

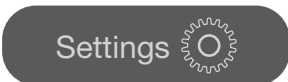

Smart Life Solutions by Orange



Window Cleaning Robot

User Manual

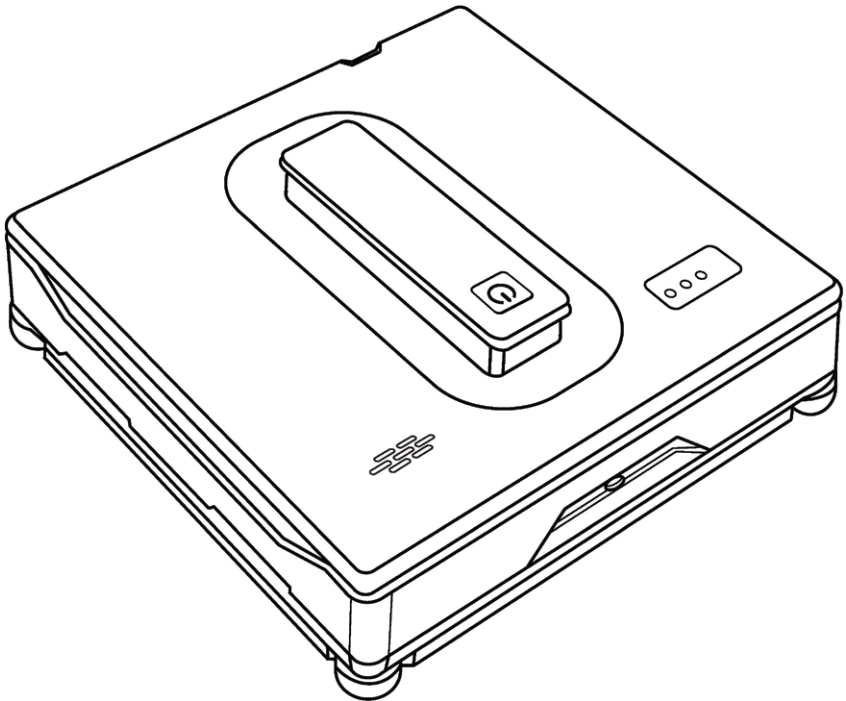

Thank you for purchasing this product,
please read the manual carefully before using it.

Table of Contents

1. Important Safety Matters and Warnings	02
2. Product Description and Parameters	04
3. Use Steps	06
4. Cleaning Function	08
5. Remote Control	10
6. Voice Assistant Function	11
7. Orange Smart Life Jo App Operation Guide	12
8. Product Maintenance	14
9. Troubleshooting	16

1. Important safety matters and warnings

1- Attention! Must read before use

1. Do not allow children to operate this product. Users with physical, sensory or psychological disorders, or those who lack knowledge of the functions and operation of this product must be supervised by a fully competent user after being familiar with the use procedures and safety risks. Users must use the product under the supervision of a fully capable user after familiarizing themselves with the use process and safety risks. Children should not use. This product should not be used by children as a toy.
2. This product is used to clean framed glass and without frames. If the window or glass frame has a damaged silicone rubber edge, please be sure to pay special attention to prevent the machine from leaking and falling off during the cleaning process. User must observe the using scenario to ensure that the product is used safely and securely and glass without frames.

2- Safety matters

- Please use the original adapter! (Using a non-original adapter may cause product failure or damage to the product.)
- Make sure the adapter has enough space for ventilation and heat dissipation during use. Do not wrap the power adapter with other objects.
- Do not use the adapter in a humid environment. Please do not touch the power adapter with wet hands during use.
- Please charge the window cleaner at the voltage that the power adapter can withstand.
- Do not use a damaged power adapter, charging cable or power plug. Before cleaning and maintaining the machine, the power plug must be unplugged and do not disconnect the power by unscrewing the extension cord to prevent electric shock.
- Do not disassemble the power adapter; if the power adapter is faulty, replace the entire power adapter. For assistance and repair, contact your local customer service or distributor.
- If the battery of this product is not handled properly, there is a risk of combustion or chemical burns and injury to the body. Please do not disassemble the battery, short-circuit the battery, throw it into a fire, or use it in an environment above 60 degrees.
- Please hand over the used battery to the local professional waste battery product recycling center for recycling, the disposal and recycling of used batteries must comply with national laws and regulations.
- Please strictly follow this manual to use this product.
- Please keep this manual for future use.
- Do not immerse this product in liquids (such as beer, water, drinks, etc.) or leave it in a humid environment for a long time.
- Do not expose this product to sunlight and keep this product away from heat sources (such as radiators, heaters, microwave ovens, gas stoves, etc.).
- Do not place this product in a strong magnetic scene.
- Please store this product out of reach of children.
- Please use this product in 0°C ~40°C (32°F~104°F) ambient temperature.
- Do not clean damaged glass and objects with uneven surfaces, this product will not produce enough vacuum suction adsorption on uneven surfaces or damaged glass machines.
- The built-in battery of this product can only be replaced by the manufacturer or designated dealer/after-sales center to avoid danger.
- Before removing the battery or handling the battery, the power must be disconnected.
- Please operate this product in strict accordance with the instructions, if any property damage or personal injury is caused by improper use, the manufacturer is not responsible for any.

Attention

1. Before use, please make sure that the safety rope is not broken, and that one end is firmly connected to the machine. The other end should be securely attached to other objects in the room to prevent the Window Cleaning Robot from falling.
2. If the glass glue of the window falls off in the middle section due to aging, or there are gaps in the four corners, etc., please use the machine carefully and ensure that the user is near the machine during the working period to prevent the machine from falling and damaging or wounding.

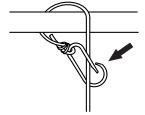

3- Risk of electric shock

- Make sure the power is completely disconnected and the machine is off before cleaning the body or maintaining the body.
- Do not drag the power plug through the extension cord, power off should be properly unplugged.
- Do not continue to use the product if the machine is damaged/the power supply is damaged.
- Machine is damaged, please contact your local after-sales center or dealer for repair.
- Do not use water to clean the machine body and power adapter.
- Do not use this product in dangerous areas such as open fires, bathrooms with water flowing from the open nozzle, by the swimming pool, etc.
- Do not damage or twist the power cord. Do not put heavy objects on the power cord or adapter to avoid damage.

4- Warnings

1. Before operation, make sure to attach the safety rope and tie it securely to a stable indoor unit.
2. Before turning on the machine, check the safety rope for damage and secure knotting. Make sure there is no damage and that the knot is secure before using the product.
3. When cleaning the glass of windows or doors without balconies, please set up a safety warning area downstairs.
4. Fully charge the built-in backup battery before use (green light on).
5. Do not use it in rainy or wet weather.
6. Turn on the machine first and then place it on the window glass.
7. Make sure the machine is safely attached to the window surface before releasing your hands.
8. Before turning off the machine, please hold the machine to avoid dropping it.
9. Do not use this product to clean frameless windows or glass.
10. Make sure the cleaning cloth is properly attached to the bottom of the machine to prevent air leakage when the window cleaner is absorbed.
11. Do not spray the machine or the bottom of the machine. spray water only on the cleaning cloth.
12. Do not allow children to use the machine.
13. Please remove any items on glass surface before use.
14. Please let hair, loose clothes, fingers, or other parts of the body keep their distance from the working parts of the machine.
15. Do not use the machine in areas of flammable and explosive solids or gases.

2. Product Description & Parameters

1- Product Mix

1. The window cleaning robot is equipped with two water holes. When the machine is cleaned to the left, the left side will spray water automatically, and when the machine is cleaned to the right side, the right side will spray water automatically. A true empty motor makes the machine adsorbed on the glass surface and walk freely on the vertical glass surface. A built-in uninterruptible power supply system (backup battery) can prevent equipment from falling due to power failure.
2. The robot has artificial intelligence, which can be voice-assisted, path planning, border and no frame detection, and automatically clean the whole window. Wireless remote control / APP can freely control the robot.

2- Product Specifications

Input voltage	AC100-240V 50Hz / 60Hz
Rated power	72W
Built-in battery	650mAh
Suction force	2500Pa
Net weight	1300g
Power outage protection time	30min
Noise	≥65dB
Control mode	Remote or smartphone APP
Edge detection	Automatic
Anti-fall control	UPS (uninterrupted power supply system)/ safety rope
Cleaning mode	Manual / Auto
Water spraying method	Manual / Auto
External dimensions	216 x 216 x 68mm

3- Product component names

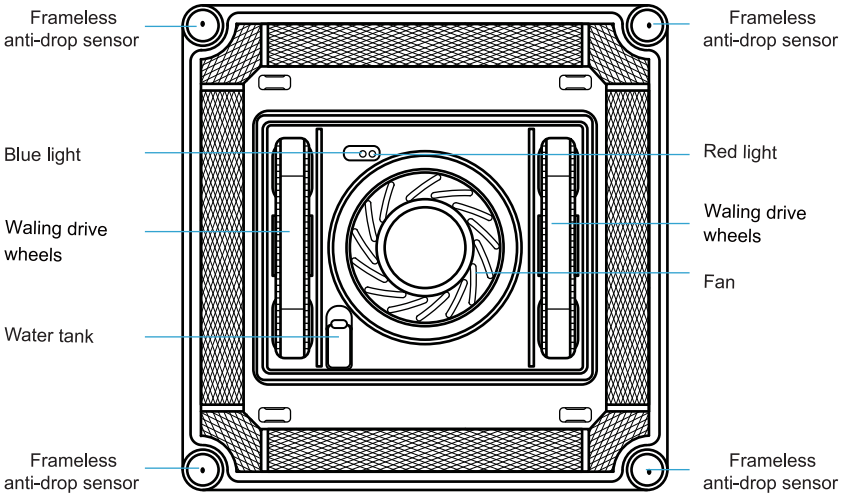
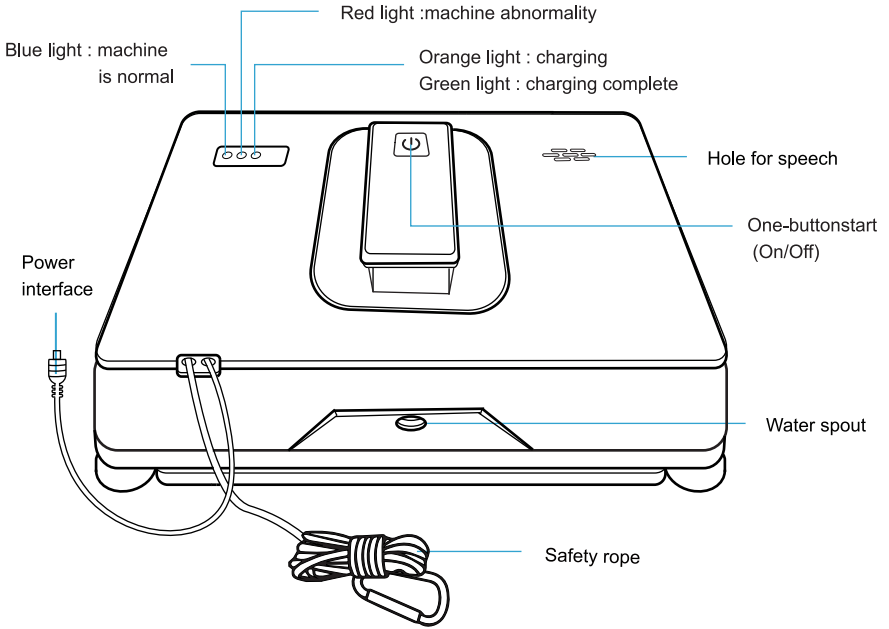

4- Packing list

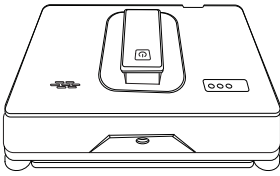

Host

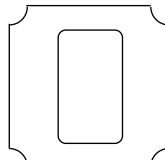

Clean cloth



Adapter + power cord



Adding water bottle



Safety rope



Remote control



User Manual

3. Use Steps

1- Install cleaning cloth

Attach the rag to the bottom of the fuselage correctly, making sure not to block the drive wheel and the anti-drop sensor. (Figure1, Figure2, Figure3)

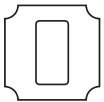

Clean Cloth

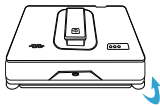

Figure 1



Figure 2

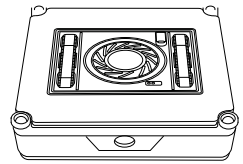

Figure 3

Note: When installing the rag, be sure not to cover the anti-drop sensors placed on the four corners of the machine. The covering may cause the machine to fall. (Do not completely wet the rag).

2- Inject water

- A. Please do not add any other cleaning agents to the water tank.
- B. Turn the machine over, open the silicone cover, and add clean and impurities-free water.
- C. Do not fill the water tank with water (80% is sufficient) to maintain stable air pressure.



Open the silicone cover.

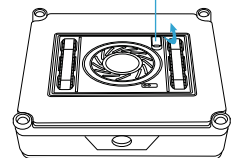

3- Connect the main unit power cord, adapter and plug

- A. Insert the DC connector (connector A) into the power interface of the machine and tighten the nut. (Figure 1).
- B. Connect the DC plug (connector B) to the adapter. (Figure 2).
- C. Connect the power supply (Figure 3).

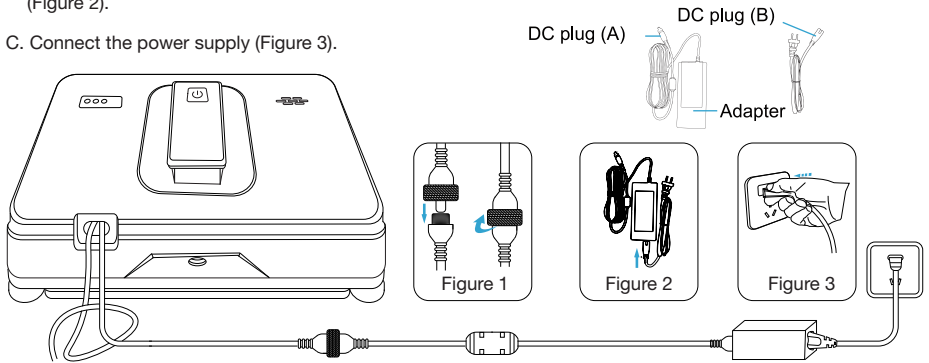

4- Connect and fix the safety rope

- A. Check that the safety rope is not broken and the connection with the robot is firm. (Figure 1)
- B. Fix the other end of the safety rope on other objects in the room to ensure that the tightening will not be dropped or fall off. (Figure 2)

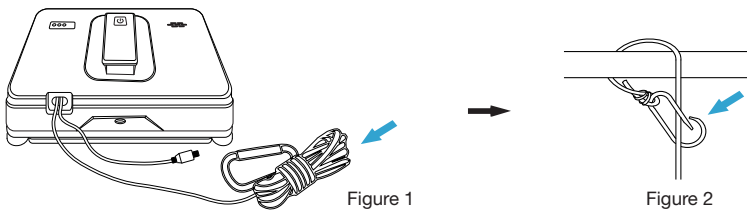

5- Start the robot

- A. Press and hold the "⏻" button for 2 seconds to turn on the machine
- B. Place the machine on the glass surface to be cleaned and press the "⏻" button again to start the cleaning program.

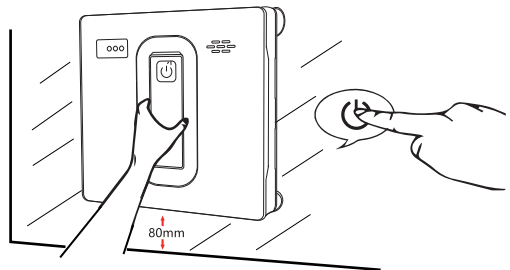

Warning: Before starting, please make sure that the four sides of the machine are at least 80mm away from the glass frame or the corners of the window.

4. Cleaning Function

1- Cleaning mode

Select the three cleaning mode on the remote control to completely clear the window.

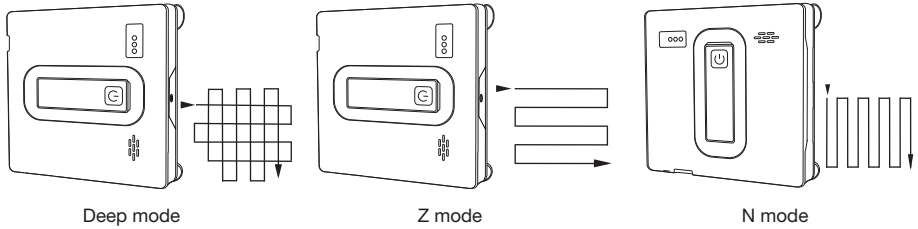

2- Water spray mode

Window cleaning robot set two water holes, when the robot to the left is cleaning, the left side sprays water, when the robot to the right is cleaning, the right side sprays water. When the robot down is cleaning, the down side sprays water.

- A. Automatic spraying mode: When the window cleaning robot is in the "Z" cleaning mode, the automatic spraying mode will be started by default, and the intermittent automatic spraying will be started.
- B. Press the **AU** button on the remote control to make the sound of "beep" and the automatic sprinkler mode is off. Press the **AU** button on the machine remote control to make two sounds of "beep beep" and the automatic sprinkler mode is on.
- C. When the window cleaning robot is in the "Z" shape cleaning mode, the machine is in the forward direction, press the  button of the remote control, the manual water spray mode is turned on, and press once to spray.

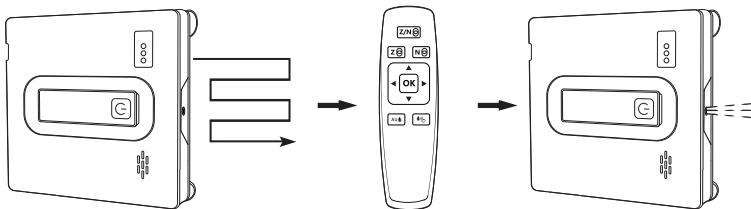

3- Fixed-point cleaning mode

- A. Press the upper, lower, left and right direction keys on the remote control to move the machine to the key cleaning position.
- B. Press the OK key on the remote control for 2 seconds to enter the fixed-point cleaning.

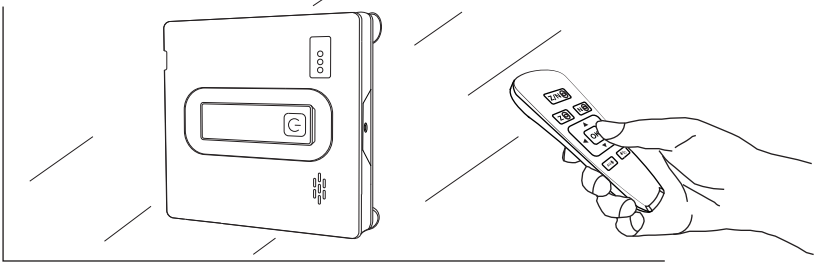

4- Power-off protection (UPS) function

- A. In case of power failure, the device will start the built-in backup battery power, which can last for 30 minutes (when the battery is fully charged).
- B. In case of power failure, the window cleaning robot will stay in the same place and will not move forward and will give a warning sound and the red/blue lights will flash alternately. At this time, the user should withdraw the machine as soon as possible to avoid falling down due to power off.
- C. The safety rope can be used to gently pull back the device; when pulling the safety rope, it should be close to the glass to avoid falling.

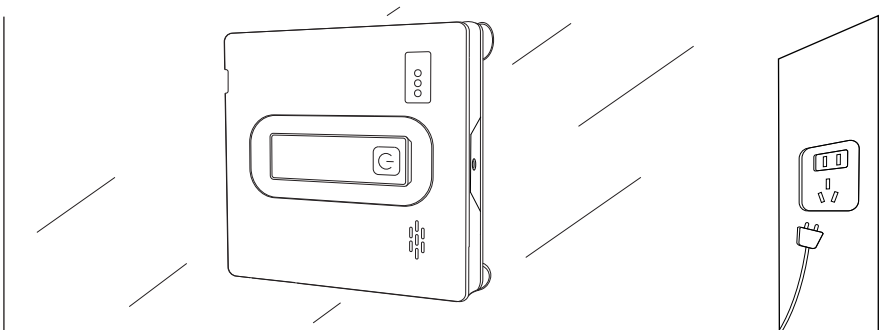





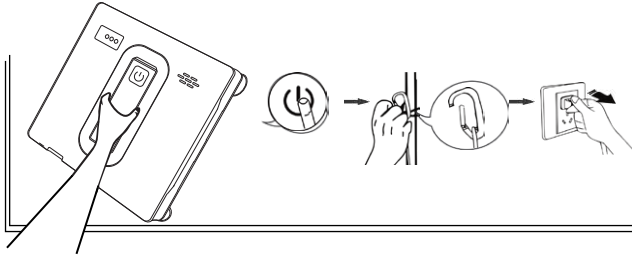





5- Cleaning completed

- A. After the robot is cleaned, it will stop at the starting point, hold the handle tightly, press and hold the "⏻" button for 3 seconds, the fan will stop working, and remove the host.
- B. Unfasten the safety rope and buckle.
- C. Disconnect power.



5. Remote Control

- A. Do not charge the remote-control battery, do not disassemble the battery, and do not put the battery on fire, there is a possibility of detonation.
- B. Please use the same specification of No. 7, AAA/RLO3 battery as required, do not use different models of batteries, there is a risk of burning the circuit, when the battery is loading and unloading, push the remote-control cover down, put the negative end of the battery into the end with the spring, and close the remote control cover. Please be careful not to reverse the positive and negative terminals of the battery.
- C. New and old batteries or different models, different types of batteries cannot be mixed.

 Z and then N-path automatic cleaning mode	 Manual upward movement	
 Z-path automatic cleaning mode	 Manual downward movement	
 N-path automatic cleaning mode	 Manually move right	
 Automatic water spray	 Manual move left	
 Manual water spray	 Fixed point cleaning	

6. Voice assistance function

serial number	Operate	Voice content
Window cleaning machine host voice function		
1	Boot prompt sound	Welcome to use our window cleaning robot, please tie the safety rope before starting. Do not use it in rainy and wet weather!
2	Window wipe machine power cord connection	Please connect the power cable
3	Start working	Please press the start button to start
4	Insufficient water in water tank	Insufficient water in water tank
Remote control voice function		
5	Remote control-Z	Start horizontal routes cleaning
6		horizontal routes cleaning mission complete
7	Remote control-N	Start vertical routes cleaning
8		vertical routes cleaning mission complete
9	Remote control-Z/N	Start deep cleaning
10		Deep cleaning mission complete
11	Remote control-automatic water-spray system AU	Start auto spray function
12		Close auto spray Function
13	Remote control-Manual water spray	Spray
14	Remote control-up	UP
15	Remote control-down	Down
16	Remote control-Left	Left
17	Remote control-Right	Right
18	Remote control-OK	Began to positioning cleaning
19		finish to positioning cleaning

7. Orange Smart Life Jo App Operation Guide

- Download Orange Smart Life Jo App



Download the application.

1. Download Orange Smart Life JO application.
2. Open the application.
3. Register using your e-mail, as the user alone is responsible for protecting the username and password for Orange Smart Life JO application, and we recommend not to share the username and password with anyone. Orange technical team will be responsible for providing setup and configuration support for the devices.
4. Select (Get a code); the verification code will be sent to your e-mail.
5. Fill out the six-digit code in the space provided on the application.
6. Enter your password.
7. Before setting up any device, you must activate the GPS feature from your mobile device.
8. Turn on Bluetooth:
Connects the robot to the power and turn on Bluetooth on your smart phone.
9. Tap “+” in the upper right corner of the Home page then tap Add Device, wait until the device name appears on the page then click Add. Make sure your device has entered the pairing mode. Wait for the device to be identified, then press Next.
10. Device has been added, now click Done.
The device screen will appear so that you can use all available options.

11. (1) Click "window cleaning robot" (2) Click "⏻" to start the robot

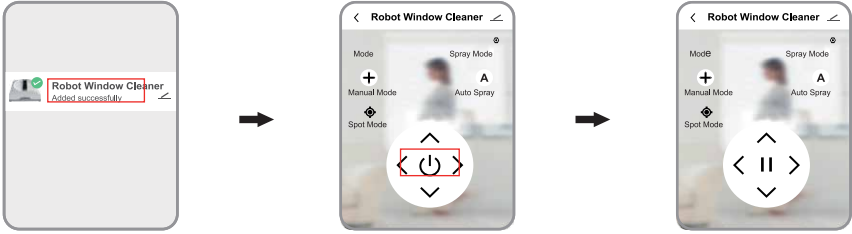

12. Click on Control panel to enter clean mode **+**

Clean mode:

- +** Manual mode
- N** N Mode
- Z** Z Mode
- Z/N** Right Mode
- ⦿** Spot Mode

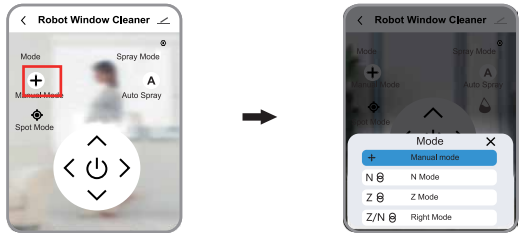

13. Click on the control panel to enter the water spray mode **A**

Water spray mode:

- A** Automatic Water Spray Mode
- M** Manual Spray Mode

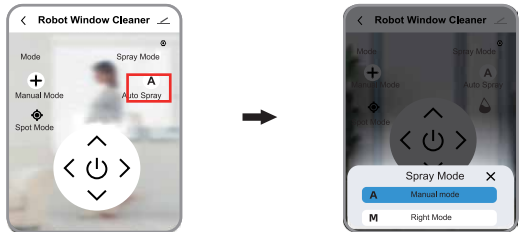

14. Click on the Control panel to access the Speech language selection **⦿**

Speech language selection:

- Chinese
- English

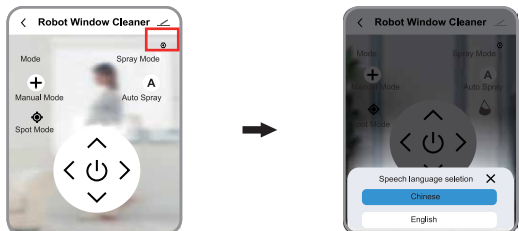

8. Product Maintenance

1. Maintenance of cleaning cloth

Please turn the body of the robot over and lay it flat and remove the rag, put it in cold water, add a small amount of detergent to clean it, wash it with clean water, and dry it.

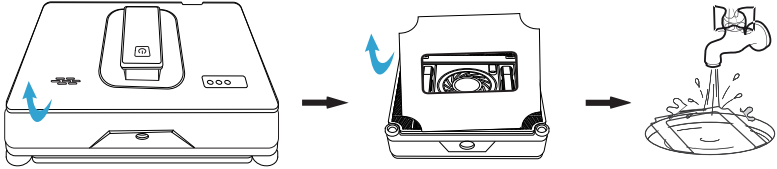

Note: Please do not use a completely drenched cloth to clean the windows. This may make your machine stuck on the glass surface due to excessive moisture and cannot be moved.

2. Frameless anti-drop sensor maintenance

Please turn robot over and lay it flat, then use a clean wipe off any dust and other dirt from the frameless anti-drop sensor the robot.

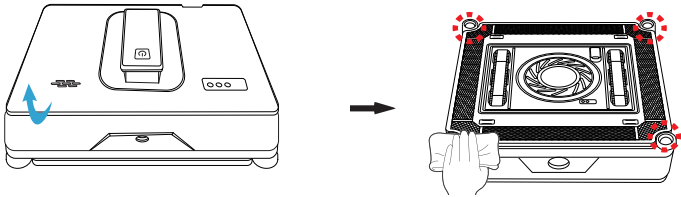

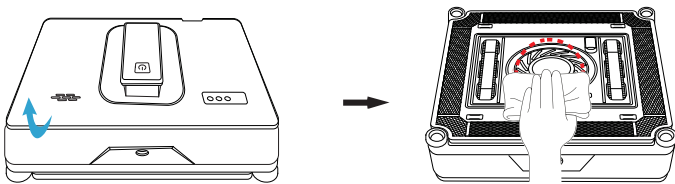

3. Fan maintenance

Please turn robot over and lay it flat, then use a clean wipe off any dust and other dirt from the fan the robot.



4. Maintenance of drive track

Turn the machine upside down and wipe dust and other dirt off the surface of the drive track with a clean, dry rag.

- A. Connect the machine to the power supply (do not press  button to start the machine).
- B. Press the  button of the remote control once, the track starts to rotate, and the machine enters the track cleaning state.
- C. Wipe the dirt and stains off the track surface with a damp towel.
- D. Press the  button of the remote control again, and then the machine exits the track cleaning mode.

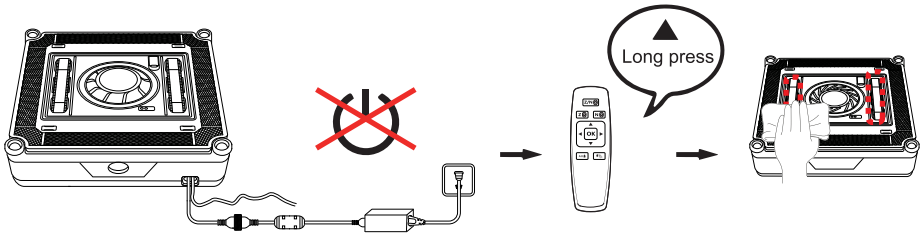

5. Window cleaning robot does not spray water

- A. Please confirm whether the water spray function switch is turned on.
- B. Clean the Atomizing plate nozzle with a clean soft cloth.
- C. Please check whether there is water in the water tank, and whether the added water is clean and free of impurities.
- D. Do not fill the water tank with water (80% is enough) to keep the air pressure stable

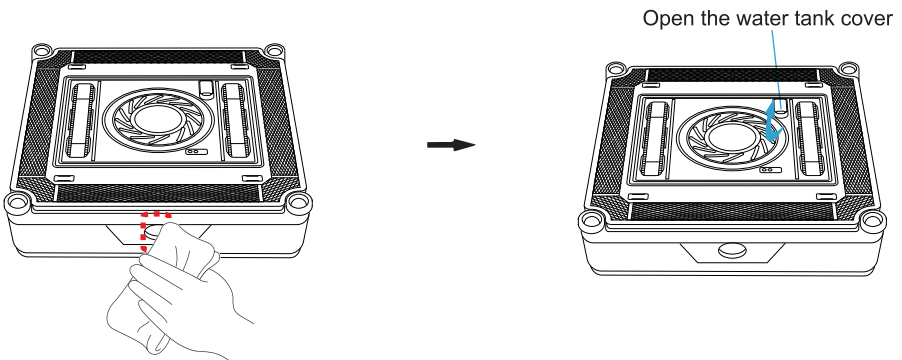

9. Troubleshooting

Fault status	Possible causes	The solution
Machine slippage.	Wiping cloth is too wet or the track is stained with water.	A. Replace the wiping cloth equipped with the machine. B. Dry the water on the track with a dry cloth. C. Clean the track wheel.
The machine is not running smoothly.	The glass is too wet or the glass surface with staining.	A. First use the remote control manually (up/down/left/right) in each direction to wipe the glass once, and then do further operations. B. Clean the track wheel.
During the operation of the machine. The machine stays on the top border of the glass and no longer cleans.	The machine hit the border; the border detection system misjudged.	A. Use the remote control to manually control the convenient operation of the position and then do further operations. B. If the remote control still cannot be operated remotely, gently pull the safety rope to manually move the machine to a convenient position.
The blue and red lights were on, and the machine did not beep	The machine is not attached to the glass.	The machine is not attached to the glass.
The buzzer sounds two times in a row during the operation of the machine.	The machine edge sensor senses the signal of moving out of the glass edge frame	Ignore
Squeaking noise between the machine and the glass during operation.	The anti-drop sensor has too much dust or the track wheel has too much dust	A. Spray water to the glass surface or wipe the cloth B. Clean off the dust attached to the anti-drop sensor C. Clean the crawler wheel.
The machine has not stopped at the starting position of the machine after the wiping action.	The friction force of each area of the wiped glass surface is different.	Attaching the machine to the glass surface.
The machine stops at a certain position in the process of operation, and the red light flashes.	Insufficient vacuum.	Check whether the wiping cloth is installed correctly
The machine cannot be started or the machine does not operate according to the preset path rules during operation.	The anti-drop sensor is abnormal and the track wheel accumulates too much dust.	A. Check whether the wipe is installed correctly. B. The anti-drop sensor is damaged. C. Clean the track wheel.
The blue light and red light are flashing, the blue light is off and the machine beeps continuously	Power supply power failure.	Check whether the power supply is disconnected or the machine power input Interface extension cable interface for poor contact (tightening nut is not tightened).
The red light and blue light blink back and forth at an interval of one second, and emit three beeps.	The machine's walking motor is abnormal	Contact after-sales service.
APP cannot search for the robot.	Factory Settings were not restored	Press the (U) button on the machine three times consecutively to restore factory Settings

* If the machine still cannot operate normally according to the manual, please contact the after-sales service staff for help.